

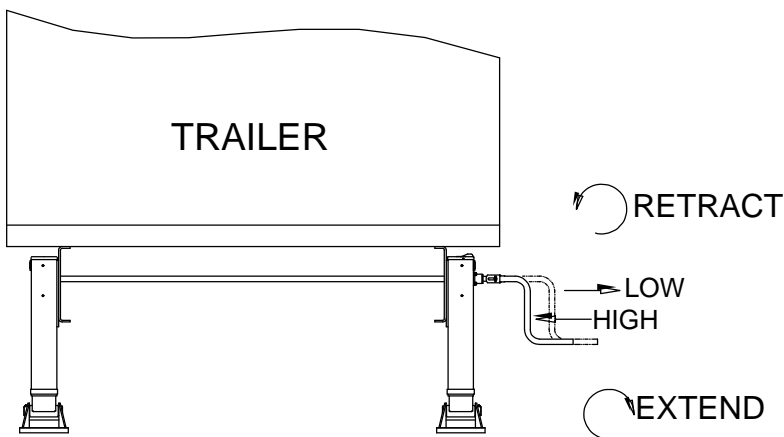

WARNING: Before attempting to operate the landing gear, you must read and understand the following procedures:

- Perform all procedures in lighted area clear of obstacles and other personnel.
- Always grip the crank handle securely with both hands.
- Maintain proper footing at all times.
- Never attempt to shift the landing gear while under load.
- Lifting and lowering of the trailer must always be done in LOW GEAR.
- **DO NOT ATTEMPT TO LIFT OR LOWER TRAILER WITH LANDING GEAR IN HIGH GEAR, AS SERIOUS PERSONAL INJURY COULD OCCUR.**
- Always secure the crank handle when not in use.

OPERATING INSTRUCTIONS



- Push crank handle **in** for **high** gear.
- Pull crank handle **out** for **low** gear.
- Turn crank:
Counterclockwise - Retract
Clockwise - Extend

FIGURE 1

Note: Both inside and outside mounts crank the same.

COUPLING PROCEDURES

STEP 1

Inflate tractor air suspension and back up **close** to the trailer centering the kingpin with the throat of the fifth wheel and **STOP! DO NOT ATTEMPT TO COUPLE UNTIL STEPS 2 THROUGH 4 ARE COMPLETED.**

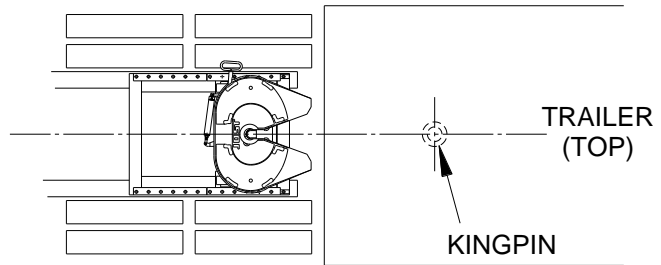

STEP 2

1. Chock trailer wheels.
2. Connect brake lines and light cord.
3. Support slack in lines to prevent interference.
4. Set trailer brakes.

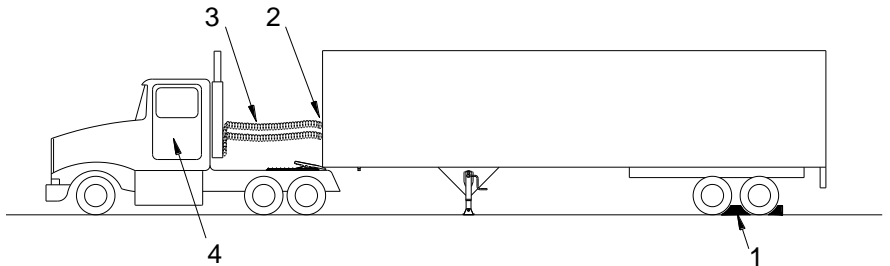

STEP 3

Make sure that the landing gear is in low gear (see figure 1) and engage crank handle.



STEP 4

Adjust trailer height so that the fifth wheel will lift the trailer.

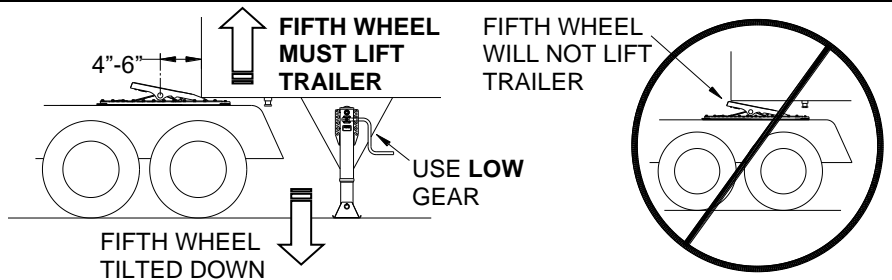

STEP 5

Couple and verify that there is no gap between fifth wheel and trailer and that the kingpin is inside the lock.

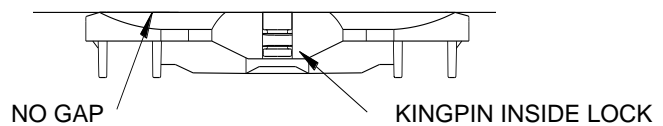

STEP 6

While still in low gear, retract landing gear until pads just come off the ground.

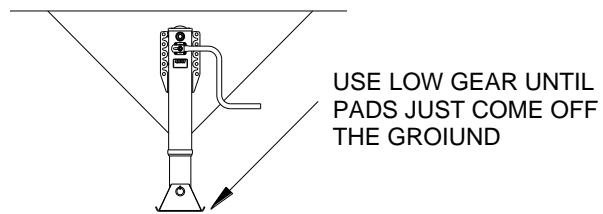

STEP 7

Switch to high gear and fully retract, secure crank handle.

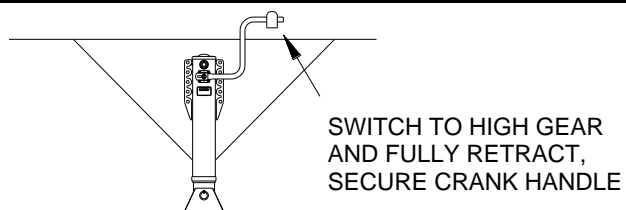

UNCOUPLING PROCEDURES

STEP 1

Position the tractor and trailer on level ground, clear of persons and obstacles.

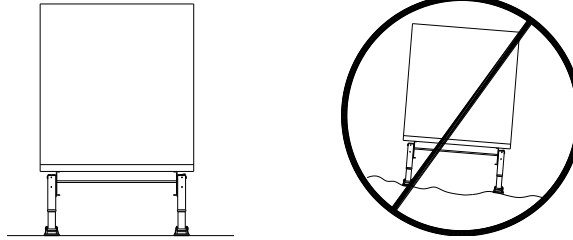

STEP 2

1. Set trailer brakes. Slowly back tractor tightly against trailer.
2. Set tractor brakes.
3. Chock trailer wheels.

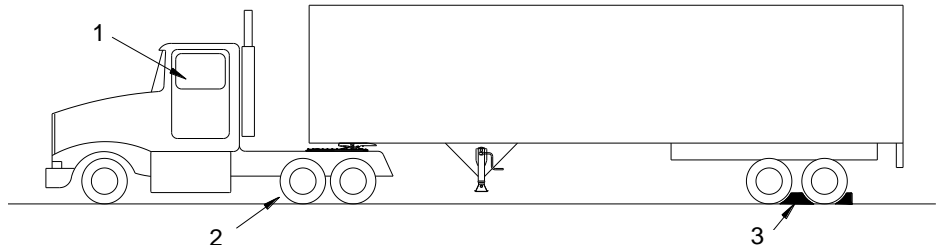

STEP 3

Shift landing gear to high gear (see figure 1) and engage crank handle.

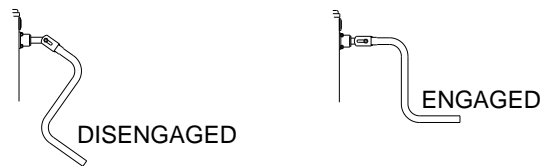

STEP 4

Extend landing gear until pads just touch the ground.

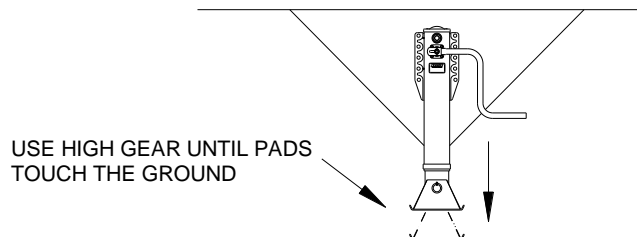

STEP 5

Switch to low gear and crank an additional 4-8 turns minimum. Secure crank handle

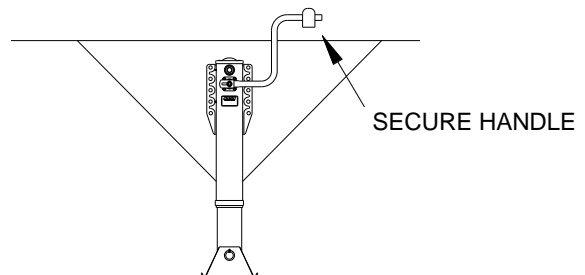

STEP 6

1. Pull fifth wheel release handle.
2. Disconnect air lines and light cord.
3. Release tractor brakes and slowly drive away from trailer.

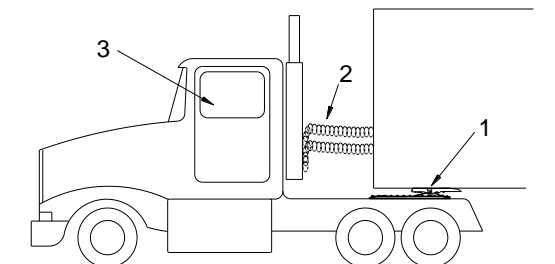

MAINTENANCE PROCEDURES

IMPORTANT: All inspections must be performed at least every 3-6 months, depending on use.

STEP 1: INSPECT LEGS AND MOUNTINGS:

| | Inspection | Possible Causes |
|--|--|--|
| | Cross shaft connection bolts and lock nuts must be secure, but allow side-to-side play in the cross shaft. | <ol style="list-style-type: none"> 1. Cross shaft bolt too tight 2. Incorrect cross shaft length |
| | Tighten or replace bolts as necessary. | <ol style="list-style-type: none"> 1. Bolts not tightened to proper torque 2. Improper coupling procedures |
| | Inspect the mounting flange for cracks or other signs of damage. | <ol style="list-style-type: none"> 1. Overloading 2. Improper coupling techniques |
| | Repair or replace any broken or damaged parts of the landing gear assembly. | <ol style="list-style-type: none"> 1. Legs not fully retracted 2. Overloading 3. Legs damaged by collision |
| | Extend the legs and, using a straightedge, inspect for bent lower leg and damaged footwear. | <ol style="list-style-type: none"> 1. Legs not fully retracted when moving trailer 2. Improper ground clearance 3. Improper coupling procedures |
| | Check for interference between powder metal bushing and trailer mounting surface. | Holes too small or in incorrect location on mounting |
| | Inspect the crank handle bolt and lock nut. Tighten or replace as necessary. | Crank handle bolt too tight (the crank handle bolt must be loose enough to allow free engagement) |
| | Check for proper crank shaft shifting in both high and low gear. | Damage to crankshaft due to contact or collision |

Important: Landing gear with excessive play should be rebuilt or replaced.

STEP 2: INSPECT ALIGNMENT:

| | Inspection | Possible Causes |
|--|---|---|
| | Using a square, check that both legs are square to the trailer and parallel with each other as shown. | <ol style="list-style-type: none"> 1. Improper installation 2. Loose bracing bolts 3. Improper coupling techniques |

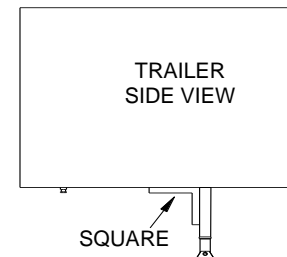
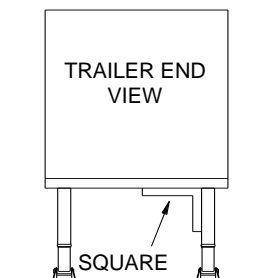

MAINTENANCE PROCEDURES

STEP 3: INSPECT FOR PROPER OPERATION: (see Operating Instructions on page 1)

| Action | Inspection (Look for the following indicators): | Possible Causes |
|--|---|--|
| 1. Shift to high gear 2. Extend leg to the ground. 3. Inspect for smooth operation. | Lower leg wobbling or twisting. | 1. Bent leg. 2. Bent lift screw. |
| | Lower leg makes a sudden drop (hopping). | Damage to lift screw threads. |
| | Inconsistent torques at different positions of the crank handle throughout the travel. | Bent or damaged screw. |
| | Without load in <u>high gear</u> the torque should not exceed approx. 7 ½ lbs at the crank handle. | 1. Damage to lift screw or lift nut. 2. Gear not lubricated at routine maintenance intervals. |
| 4. Extend leg to the ground. 5. Shift to low gear. 6. Crank an additional 8 to 10 turns. | With an empty trailer in <u>low gear</u> the torque should not exceed approx. 19 lbs at the crank handle. | Gear not lubricated at routine maintenance intervals. |

If any of the above indicators are present the landing gear should be disassembled and inspected for actual wear and/or damage. Replace as required.

STEP 4: LUBRICATE:

The only solution for corrosion problems is regular re-lubing of the legs in both the gearbox (upper grease zerk) and the screw/nut cavity (lower grease zerk). This action will place a fresh coat of grease on all the surfaces protecting them from rust.

- Lubricate at 5 years, then every 90 days thereafter. Lubricate more frequently in applications where the landing gear are exposed to excessive moisture (liquid salt water spray), dust, or if they are not used for extended periods.
- Lubricate with the trailer securely coupled to a tractor (see coupling instructions on page 2).
- Employ a lubricant compatible with the original type of grease used:
 Standard – Lithium base 1-2% Moly EP-2
 Low temperature – Arctic-grade, all weather white grease

Warning: Do not use any lubricants containing Teflon

| Bevel Gear Lubrication Instructions: | |
|---|---|
| | Lubricate in the top grease fitting as shown. At least 4oz. (50 pumps on a hand grease gun). |

| Lift Screw/Nut Lubrication Instructions: | |
|---|--|
| It is not required to perform these steps if the direct lubrication (outlined in addendum) were completed. | |
| | Fully retract the landing gear, then using high gear extend 7 turns. |
| | Lubricate in the bottom grease fitting as shown. At least 4oz. (50 pumps on a hand grease gun). |
| | Extend and retract the landing gear to apply grease to the entire length of the screw. |

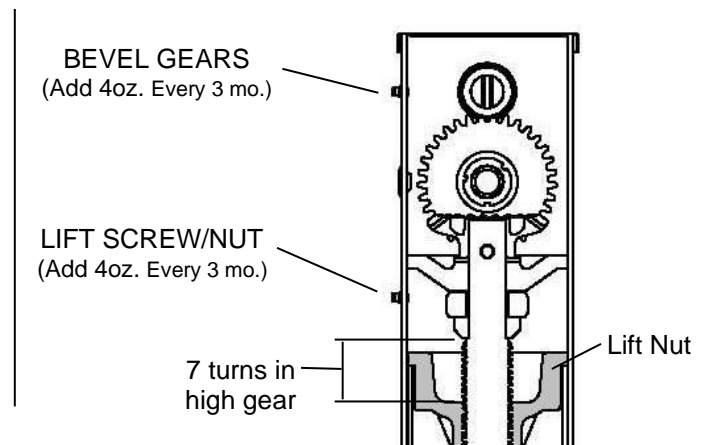

TROUBLE-SHOOTING POINTS

| Problem | Cause | Correction |
|-------------------------------------|---|---|
| Hard to crank landing gear | 1. Turning crank in wrong direction. | 1. See below for proper crank handle rotation. |
| | 2. Attempting to raise or lower trailer in high gear. | 2. Shift to low gear (see figure 1, page1). DO NOT ATTEMPT TO LIFT OR LOWER IN HIGH GEAR. |
| | 3. Legs are already fully extended or retracted. | 3. Turn crank in opposite direction to retract or extend. |
| | 4. Cross shaft binding: - over-tightened bolts. - cross shaft bent or too long. | 4. Inspect cross shaft bolts. Back off bolts to allow lateral (side-to-side) movement of cross shaft. Use self-locking type nuts only. |
| | 5. Mis-aligned landing gear legs. | 5. Legs must be parallel and extend and retract evenly. Remove cross shaft; adjust landing gear legs to same height. |
| | 6. Lack of grease. | 6. Grease landing gear as directed in step 4 on page 5. If problem remains, the elevating screw may be damaged. Replace the damaged landing gear leg. |
| | 7. Damaged lift screw or lift nut. | 7. Check landing gear for signs of impact (accident) damage. Disconnect cross shaft and crank legs individually to determine which leg is damaged. Replace damaged leg. |
| | 8. Interference between powder metal bushing and trailer mounting surface | 8. Hole in trailer mounting surface may need to be enlarged. |
| Shaft turns but legs do not operate | 1. Broken shaft or shaft bolt. | 1. Replace broken bolt(s) and shaft as needed. |
| | 2. Broken pinion gear or bevel gear or gear pins. | 2. Replace broken gear(s) or pin. |
| Shaft does not turn | 1. Broken gear teeth. | 1. Replace broken gear(s). |
| | 2. Damaged lift screw. | 2. Replace inner leg or entire landing gear leg. |
| | 3. Seized lift screw or nut | 3. Replace inner leg or entire landing gear leg. |
| | 4. Bent inner or outer leg tube. | 4. Replace bent inner leg or outer leg, or entire landing gear leg. |
| Crank shaft skips when cranking | 1. Broken gear teeth. | 1. Replace broken gear(s). |